

# CORAX

As confirmed by many users worldwide, the CORAX is the standard for today's poultry lighting applications. It is a main lighting solution that can be applied in almost every type of poultry house.

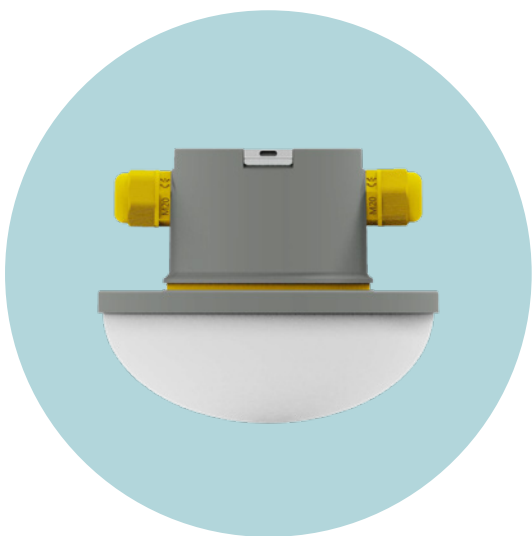

## Specifications

Operating voltage	48VDC
Dimmer type	HATO 48VDC power supply
Dim range	0 - 100%
Light source	LED
Flicker-free	Yes
Expected average lifetime white LEDs	50,000h
Operating temperature	-10°C (14°F) <math><Ta</math> +40°C (104°F)
Nett weight	375 gr / 0.83 lbs
Cover material	Impact resistant PMMA
Base material	ABS
Warranty	8 Years*
Application	Poultry

Type	Power Consumption	Light output	Efficacy	Light colour (CCT)	CRI	Energy Class	Made in
<b>CORAX</b>	8.7W	1050lm	121lm/W	3000K	> 80		China / NL <sup>1</sup>
<b>CORAX CW</b>	8.7W	1110lm	128lm/W	4500K	> 80		China <sup>2</sup>
<b>CORAX DDS**</b>	warm white: 9.7W*** cold white: 9.7W***	warm white: 1050lm cold white: 1110lm	warm white: 108lm/W cold white: 114lm/W	warm white: 2500K cold white: 6700K	> 80		China <sup>2</sup>
<b>CORAX XL</b>	15.4W	1750lm	112lm/W	3000K	> 80		China / NL <sup>1</sup>

\* Ask your sales representative for the product specific warranty terms and conditions.

\*\* Limit power to max 15W when mixing colours

\*\*\* Includes UV-A LED

<sup>1</sup> The corresponding documents CVO and EUR1 are available on request

<sup>2</sup> Made in NL also available on request.

# CORAX

Colour options	Power consumption	Light output	Efficacy	Dominant wavelength
Blue	3W 6W	40lm 80lm	13.3lm/W	463nm
Red	3W 6W	163.5lm 327lm	54.5lm/W	620nm

## Spectrum

Measured with the HATO ONE spectrum meter

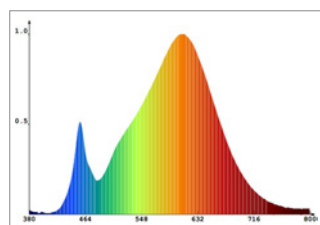

CORAX

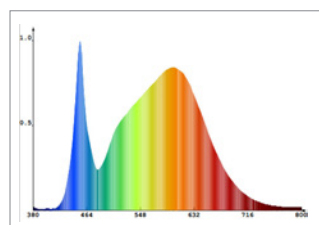

CORAX - CW

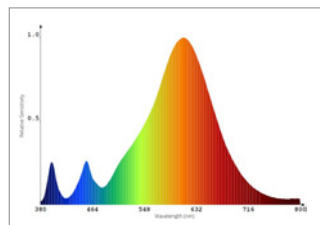

CORAX DDS - warmwhite

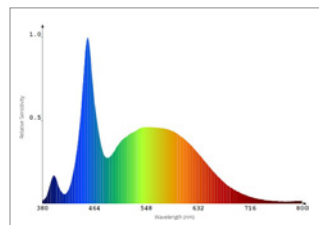

CORAX DDS - coldwhite

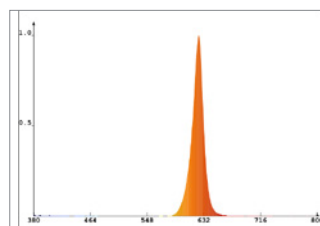

Red

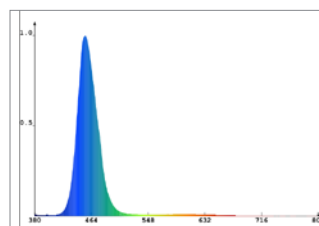

Blue

## Light spread

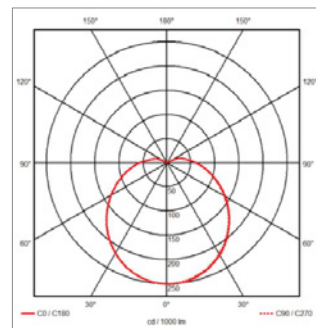

# CORAX

## Dimensions

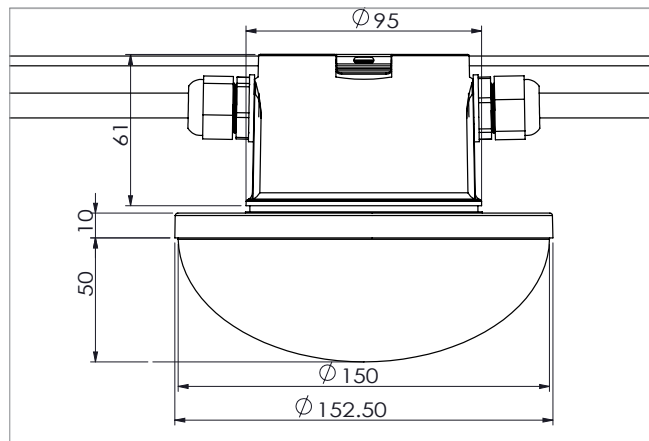

## Accessories incl.

Clip + triangle for pendant mounting:  
Maximum diameter of steel cable is 3.5 mm / 0.14 inch

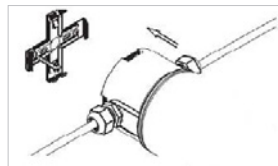

Pendant mounting

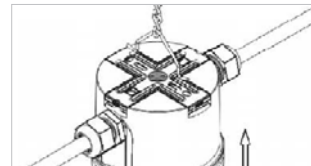

Cable mounting

## Pre-wire (14AWG)

Pre-wiring is possible for CORAX installations. This means we connect all the cables exactly as defined in the light plan. The only thing you have to do is hang the lamps at the right place and connect them to the power supply. Scan QR code for more information.

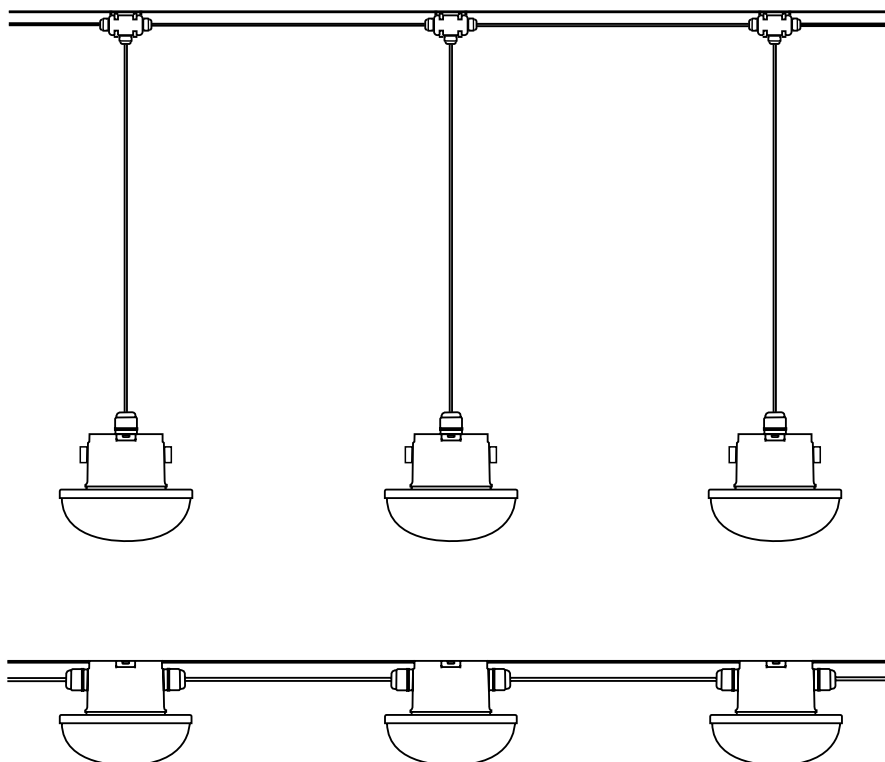

# CORAX

## Installation example

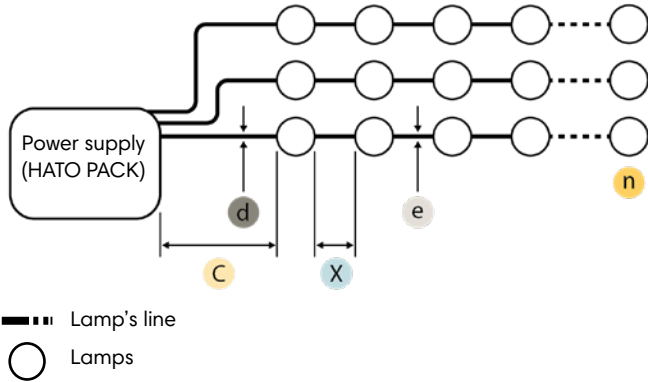

## Connection in string Extra V+wire

CORAX - W8.7 with 3 pole cable

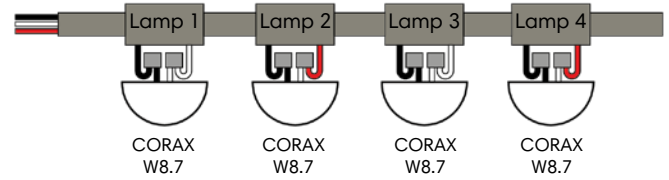

- Red wire : V+1 white
- White wire: V+2 white
- Black wire: V-shared

## Installation according to IEC/CE with Smart E-Fuse 6A in HATO PACK

### Maximum lamps in one line

Cable between lamps	CORAX-W8.7				CORAX-DDS		CORAX-XL			CORAX-3-W8.7-R6		CORAX-4-W8.7-x			
	2 x 2.5mm <sup>2</sup>	3 x 2.5mm <sup>2</sup>	4 x 2.5mm <sup>2</sup>	5 x 2.5mm <sup>2</sup>	3 x 2.5mm <sup>2</sup>	5 x 2.5mm <sup>2</sup>	2 x 2.5mm <sup>2</sup>	3 x 2.5mm <sup>2</sup>	4 x 2.5mm <sup>2</sup>	5 x 2.5mm <sup>2</sup>	3 x 2.5mm <sup>2</sup>	4 x 2.5mm <sup>2</sup>	4 x 2.5mm <sup>2</sup>	5 x 2.5mm <sup>2</sup>	
Outputs used	1	2	2	2	2x1	2x2	1	2	2	2	2x1	1x2	3x1	1x2 2x1	
Distance between lamps	3m / 9.8ft	23	27	30	32	22	26	16	19	21	22	23	27	23	27
	3.5m / 11.5ft	22	26	29	31	20	24	15	18	20	22	22	26	22	26
	4m / 13.1ft	20	24	27	29	19	23	14	17	19	21	20	24	20	24
	4.5m / 14.8ft	19	23	26	28	18	22	14	16	18	20	19	23	19	23
	5m / 16.4ft	18	22	25	27	17	21	13	15	17	19	18	22	18	22

### Max length connection cable [m / ft]

Cable thickness	2.5 mm <sup>2</sup>	19 m 61 ft	24 m 78 ft	29 m 94 ft	34 m 110 ft	18 m 58 ft	22 m 73 ft	15 m 50 ft	19 m 63 ft	23 m 76 ft	28 m 91 ft	19 m 61 ft	24 m 78 ft	19 m 61 ft	24 m 78 ft
	4 mm <sup>2</sup>	30 m 98 ft	38 m 125 ft	46 m 150 ft	54 m 176 ft	28 m 93 ft	36 m 117 ft	25 m 80 ft	31 m 101 ft	37 m 122 ft	44 m 145 ft	30 m 98 ft	38 m 125 ft	30 m 98 ft	38 m 125 ft
	6 mm <sup>2</sup>	45m 147 ft	57 m 188 ft	69 m 225 ft	80 m 264 ft	42m 138 ft	54 m 176 ft	37 m 120 ft	46 m 152 ft	56 m 183 ft	66 m 218 ft	45 m 157 ft	57 m 188 ft	45 m 147 ft	57 m 188 ft

Specifications are subject to change without prior notice. For lines not connected to a POWER PACK with Smart E-Fuse, number of lamps in a line can vary.

Please ask your sales representative in case of doubt.

# CORAX

Installation according to UL/CSA with Smart E-Fuse 2A in HATO PACK\*

### Maximum lamps in one line

Cable between lamps	CORAX-W8.7				CORAX-DDS			CORAX-XL			CORAX-3-W8.7-R6		CORAX-4-W8.7-x		
	2 x 14 AWG	3 x 14 AWG	4 x 14 AWG	5 x 14 AWG	3 x 14 AWG	5 x 14 AWG	2 x 14 AWG	3 x 14 AWG	4 x 14 AWG	5 x 14 AWG	3 x 14 AWG	5 x 14 AWG	4 x 14 AWG	5 x 14 AWG	
Outputs used	1	2	3	4	2x1	2x2	1	2	3	4	2x1	2x2	3x1	1x2 2x1	
Distance between lamps	3m / 9.8ft	11	24	28	31	10	22	6	12	20	21	11	24	11	24
	3.5m / 11.5ft	11	24	27	29	10	22	6	14	19	20	11	24	11	24
	4m / 13.1ft	11	22	25	28	10	21	6	14	18	19	11	22	11	22
	4.5m / 14.8ft	11	21	24	26	10	20	6	14	17	18	11	21	11	21
	5m / 16.4ft	11	20	23	25	10	19	6	14	16	18	11	20	11	20

### Max length connection cable [m / ft]

Cable thickness	14 AWG	12 AWG	10 AWG	14 AWG	12 AWG	10 AWG	14 AWG	12 AWG	10 AWG	14 AWG	12 AWG	10 AWG	14 AWG	12 AWG	10 AWG
14 AWG	29 m 96 ft	21 m 70 ft	26 m 84 ft	29 m 95 ft	29 m 95 ft	22 m 71 ft	30 m 99 ft	21 m 69 ft	20 m 67 ft	24 m 79 ft	29 m 96 ft	21 m 70 ft	29 m 96 ft	21 m 70 ft	
12 AWG	47 m 153 ft	34 m 112 ft	41 m 133 ft	46 m 151 ft	46 m 151 ft	34 m 112 ft	48 m 158 ft	34 m 110 ft	33 m 107 ft	38 m 126 ft	47 m 153 ft	34 m 112 ft	47 m 153 ft	34 m 112 ft	
10 AWG	74 m 244 ft	54 m 177 ft	65 m 212 ft	73 m 240 ft	73 m 240 ft	54 m 178 ft	77m 252 ft	53 m 175 ft	52 m 170 ft	61 m 200 ft	74 m 244 ft	54 m 177 ft	74 m 244 ft	54 m 177 ft	

Specifications are subject to change without prior notice. For lines not connected to a POWER PACK with Smart E-Fuse, number of lamps in a line can vary. Please ask your sales representative in case of doubt.

### Markings



\* Protection test against penetration of water IPX7 (protected against the effect of immersion between 15cm and 1m)