

# PULSA

Our well-known CORAX in a plug & play version; it won't get any better! The PULSA is a main lighting solution that can be applied in almost every type of poultry house.

PULSA: A responsible investment for the long term.

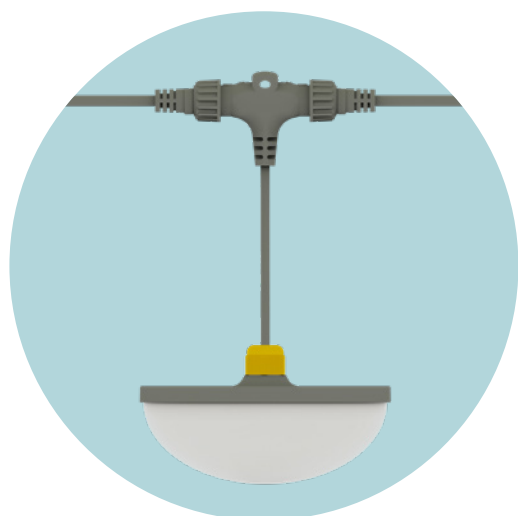

## Specifications

|                                      |                                 |
|--------------------------------------|---------------------------------|
| Operating voltage                    | 48VDC                           |
| Dimmer type                          | HATO 48VDC power supply         |
| Dim range                            | 0 - 100%                        |
| Light source                         | LED                             |
| Flicker-free                         | Yes                             |
| Expected average lifetime white LEDs | 50,000h                         |
| Operating temperature                | -10°C (14°F) <Ta< +40°C (104°F) |
| Nett weight                          | 375 gr / 0.83 lbs               |
| Cover material                       | Impact resistant PMMA           |
| Base material                        | ABS                             |
| Warranty                             | 8 Years*                        |
| Application                          | Poultry                         |

| Type               | Power consumption                                | Light output                             | Efficacy                                   | CCT                                    | CRI  | Energy class |
|--------------------|--|--|--|--|------|--------------|
| <b>PULSA</b>       | 8.7W   | 1050lm                                   | 121lm/W                                    | 3000K                                  | > 80 |              |
| <b>PULSA CW</b>    | 8.7W   | 1110lm                                   | 128lm/W                                    | 4500K                                  | > 80 |              |
| <b>PULSA DDS**</b> | warm white: 9.7W<br>cold white: 9.7W<br>UV-A: 1W | warm white: 1050lm<br>cold white: 1110lm | warm white: 108lm/W<br>cold white: 114lm/W | warm white: 2500K<br>cold white: 6700K | > 80 |              |
| <b>PULSA XL</b>    | 15.4W  | 1750lm                                   | 112lm/W                                    | 3000K                                  | > 80 |              |

| Colour options | Power consumption | Light output     | Efficacy | Dominant wavelength |
|----------------|-------------------|------------------|----------|---------------------|
| Blue           | 3W<br>6W          | 40lm<br>80lm     | 13.3lm/W | 463nm               |
| Red            | 3W<br>6W          | 163.5lm<br>327lm | 54.5lm/W | 620nm               |

\* Ask your sales representative for the product specific warranty terms and conditions.

\*\* Limit power to max 15W when mixing colours

# PULSA

## Dimensions

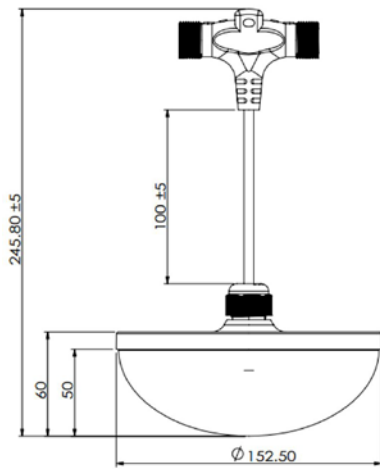

## Spectrum

Measured with the HATO ONE spectrum meter

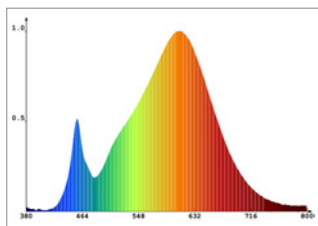

PULSA

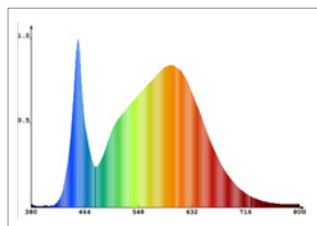

PULSA - cold white

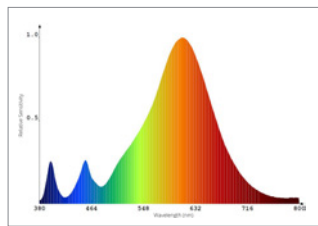

PULSA DDS - warm white

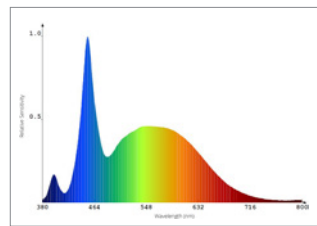

PULSA DDS - cold white

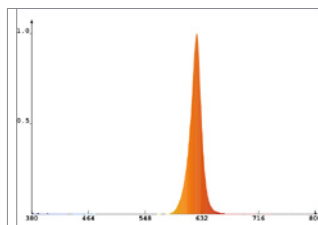

Red

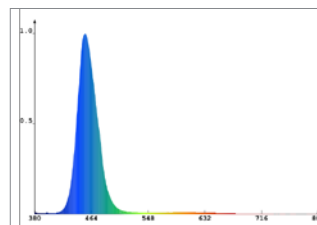

Blue

## Light spread

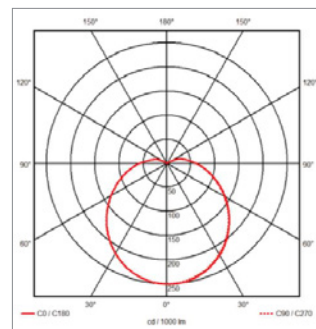

# PULSA

## Installation example

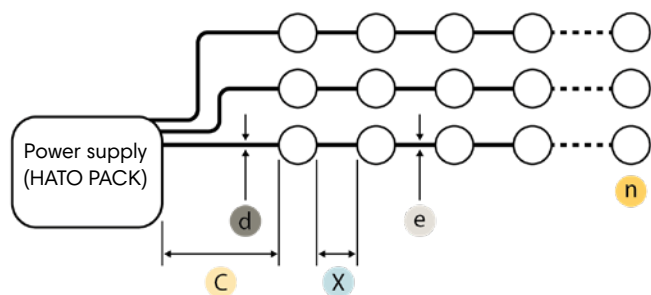

- Lamp's line
- Lamps

## Installation according to IEC/CE with T3.15A fuse in HATO PACK

Maximum lamps in one line (T3.15A fuse, IEC/CE)

|                               |               | PULSA-W8.7<br>PULSA-2-W8.7-y | PULSA-DDS              | PULSA-XL<br>PULSA-2-W15.4-x | PULSA-3-W8.7-R6        |   |
|-------------------------------|---------------|------------------------------|------------------------|-----------------------------|------------------------|---|
| <b>Cable between lamps</b>    |               | 2 x 2.5mm <sup>2</sup>       | 3 x 2.5mm <sup>2</sup> | 2 x 2.5mm <sup>2</sup>      | 3 x 2.5mm <sup>2</sup> | e |
| <b>Fuse outputs used</b>      |               | 1                            | 2x1                    | 1                           | 2x1                    |   |
| <b>Distance between lamps</b> | 3m / 9.8ft    | 19                           | 17                     | 10                          | 19                     | n |
|                               | 3.5m / 11.5ft | 19                           | 17                     | 10                          | 19                     |   |
|                               | 4m / 13.1ft   | 19                           | 17                     | 10                          | 19                     |   |
|                               | 4.5m / 14.8ft | 18                           | 17                     | 11                          | 18                     |   |
|                               | 5m / 16.4ft   | 17                           | 16                     | 11                          | 17                     |   |

Max length connection cable [m / ft]

|                        |                     | PULSA-W8.7<br>PULSA-2-W8.7-y | PULSA-DDS     | PULSA-XL<br>PULSA-2-W15.4-x | PULSA-3-W8.7-R6 |   |
|------------------------|---------------------|------------------------------|---------------|-----------------------------|-----------------|---|
| <b>Cable thickness</b> | 2.5 mm <sup>2</sup> | 19 m<br>60 ft                | 19 m<br>60 ft | 19 m<br>62 ft               | 19 m<br>60 ft   | c |
|                        | 4 mm <sup>2</sup>   | 29 m<br>95 ft                | 29 m<br>95 ft | 30 m<br>98 ft               | 29 m<br>95 ft   |   |
|                        | 6 mm <sup>2</sup>   | 46m<br>151 ft                | 46m<br>151 ft | 48 m<br>156 ft              | 46m<br>151 ft   |   |

# PULSA

## Installation according to UL/CSA with F1.6A fuse in HATO PACK

Maximum lamps in one line (F1.6A fuse, UL/CSA)

|                     |                        | PULSA-W8.7<br>PULSA-2-W8.7-y | PULSA-DDS | PULSA-XL<br>PULSA-2-W15.4-x | PULSA-3-W8.7-R6 |   |   |
|---------------------|------------------------|------------------------------|-----------|-----------------------------|-----------------|---|---|
| Cable between lamps |                        | 2x 14AWG                     | 3x 14AWG  | 2x 14AWG                    | 3x 14AWG        | e |   |
| Fuse outputs used   |                        | 1                            | 2x1       | 1                           | 2x1             |   |   |
| X                   | Distance between lamps | 3m / 9.8ft                   | 9         | 8                           | 5               | 9 |   |
|                     |                        | 3.5m / 11.5ft                | 9         | 8                           | 5               | 9 |   |
|                     |                        | 4m / 13.1ft                  | 9         | 8                           | 5               | 9 | n |
|                     |                        | 4.5m / 14.8ft                | 9         | 8                           | 5               | 9 |   |
|                     |                        | 5m / 16.4ft                  | 9         | 8                           | 5               | 9 |   |

Max length connection cable [m / ft]

|   |                 | PULSA-W8.7<br>PULSA-2-W8.7-y | PULSA-DDS      | PULSA-XL<br>PULSA-2-W15.4-x | PULSA-3-W8.7-R6 |                |   |
|---|-----------------|------------------------------|----------------|-----------------------------|-----------------|----------------|---|
| d | Cable thickness | 14AWG                        | 36 m<br>116 ft | 36 m<br>116 ft              | 36 m<br>116 ft  | 36 m<br>116 ft |   |
|   |                 | 12AWG                        | 56 m<br>184 ft | 56 m<br>184 ft              | 56 m<br>184 ft  | 56 m<br>184 ft | C |
|   |                 | 10AWG                        | 89m<br>291 ft  | 89m<br>291 ft               | 89m<br>291 ft   | 89m<br>291 ft  |   |

### Markings



\* Protection test against penetration of water IPX7  
(protected against the effect of immersion between 15cm and 1m)