

SYLVA

Embrace nature with SYLVA, the leading gradient lighting solution that revolutionizes broiler well-being and farm efficiency.

Its higher durability and globally recognized HATO Lighting quality, with just 1.2W consumption, allows SYLVA to deliver top performance at the lowest costs.

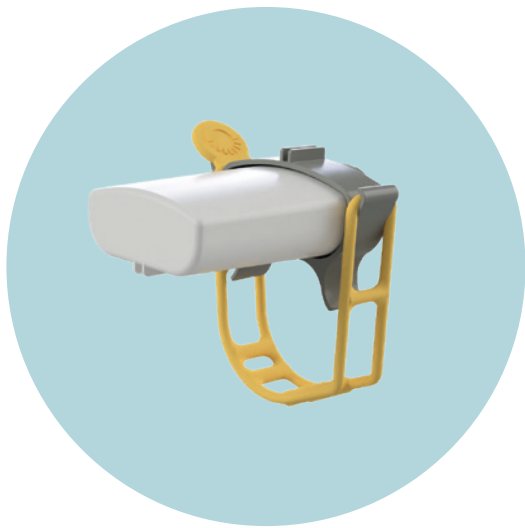

Specifications

Operating voltage:	48VDC
Connection:	Plug & Play
Light source:	LED
Flicker-free:	Yes
CRI:	>80
Expected average lifetime:	50,000h - L90B10 at 25°C
Operating temperature:	14°F(-10°C) < Ta < 104°F(+40°C)
Storage temperature:	-13°F (-25°C) < Ta < 176°F (+80°C)
Net weight:	55 gr
Base material:	PC
Cover material:	PC
IP	IP67
Warranty:	5 years*
Application:	Poultry

Barcode	Power consumption	Light output	Efficacy	Dimmable	Maximum number of lamps in line	Maximum line length	Light colour	Made in
7848	1.2W	185lm	154lm/W	No	See below	600ft	5000K	China
7936	1.2W	185lm	154lm/W	0 – 100%**	See below	560ft	5000K	China

Accessories

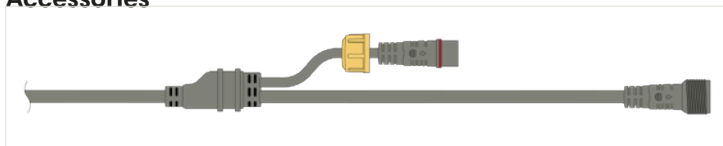

Y Connector cable 7.17 feet

7851

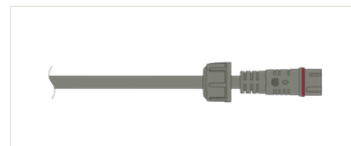

DC Connection cable

(Different codes)



End cap

3001/01

* Ask your sales representative for the product specific warranty terms and conditions.

** Dimmable with HATO power supply

SYLVA

Dimensions

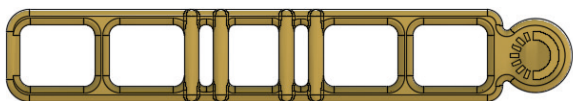
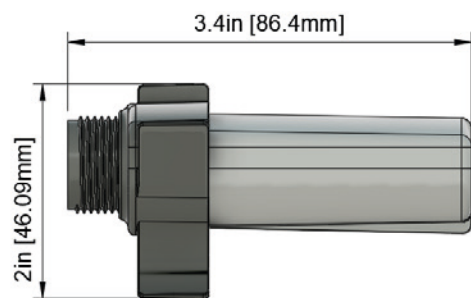
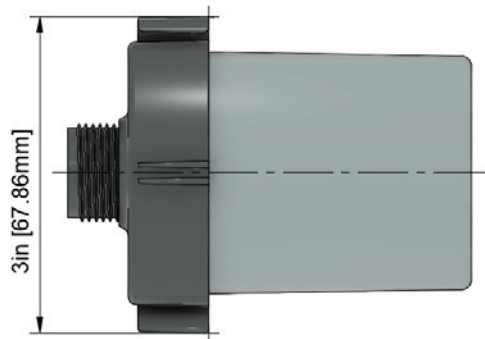

Packaging information

Size: 14.56" x 14.56" x 18.9"
(370mm x 370mm x 480mm)

Number of units per box: 100

Installation example:

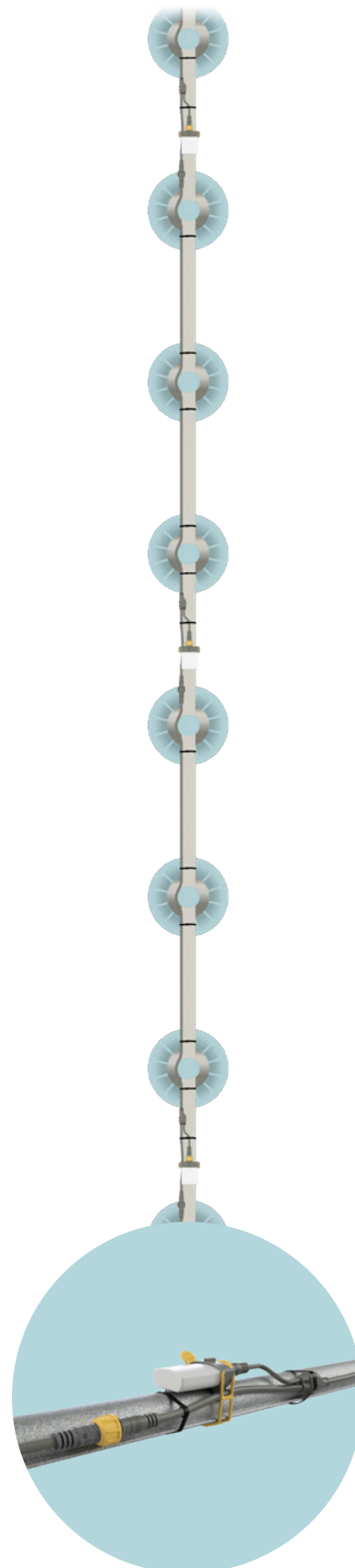

SYLVA

Installation Notes

Consider light output at the end of the line according to maximum number of lamps in line.

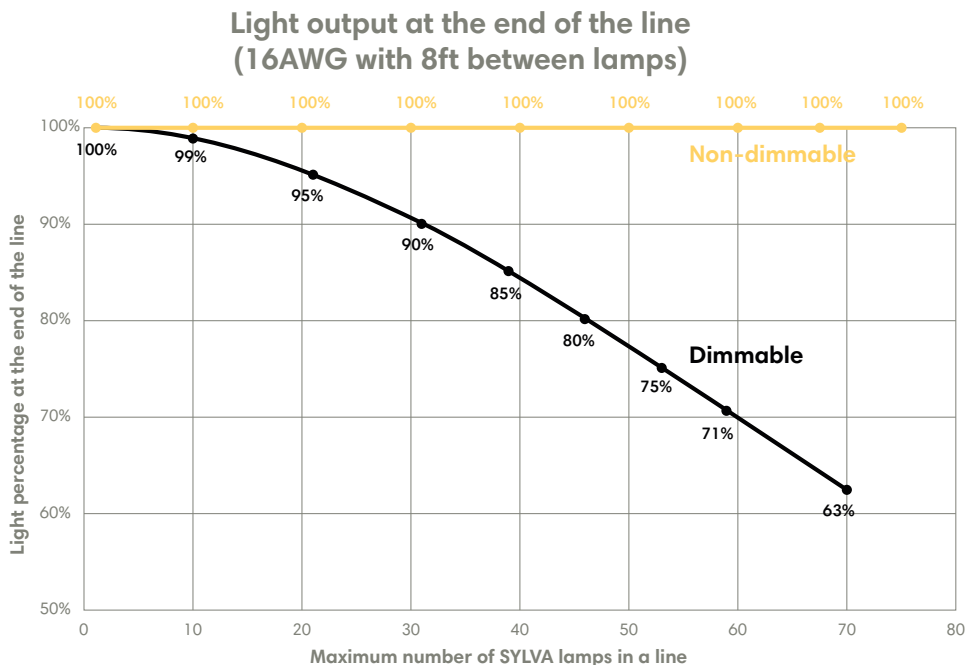

Light spread

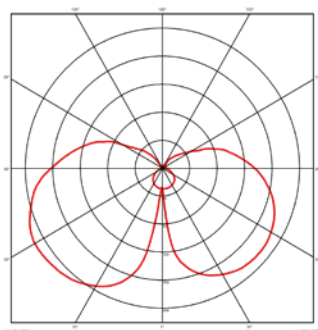

Markings



Notes

This product is designed for feeding tubes with a maximum diameter of 1 3/4".

Always use HATO Power Pack with Smart E-fuse.

Select the right HATO Power Pack type depending on local requirements.